



INSTALLATION GUIDE

Performance Intercooler Kit, Fits 2023+ Toyota GR Corolla

SKU: MMINT-GRC-23KBKBK, MMINT-GRC-23KBKRD, MMINT-GRC-23KSLBK, MMINT-GRC-23KSLRD

TABLE OF CONTENTS

1. RESOURCES & CONTACT INFO
2. EXPLODED VIEW
PARTS BREAKDOWN
4. IMPORTANT SAFETY INFORMATION
INSTALL TIME & DIFFICULTY
REQUIRED TOOLS
14. DISPOSAL & WARRANTY INFORMATION

RESOURCES & CONTACT



CALL 1.877.466.4744

CUSTOMER SERVICE HOURS: MON-FRI 9:00AM-7:00PM EST



@MISHIMOTO



@GOMISHIMOTO



MISHIMOTO



@MISHIMOTO



ENGINEERING BLOG

WWW.MISHIMOTO.COM/ENGINEERING

PARTS BREAKDOWN

PART NUMBER	DESCRIPTION	QTY
MM91469	INTERCOOLER	1
MM10030-01	ADAPTER	2
MM10035-01	RETAINER	2
MM10038-01	LOWER DUCT	1
MM10038-02	UPPER DUCT	1
MM10038-03	BRACKET 1	1
MM10038-04	BRACKET 2	1

PARTS BREAKDOWN

PART NUMBER	DESCRIPTION	QTY
HF5X0.8-10B	M5 BOLT (10MM LENGTH)	4
HF5X0.8-14B	M5 BOLT (14MM LENGTH)	4
HF6X1.0-10B	M6 BOLT (10MM LENGTH)	6
HF6X1.0-30D	M6 BOLT (30MM LENGTH)	3
MM1152-24	M6 WASHER	1
MM1165-07	1/8" NPT PLUG	1

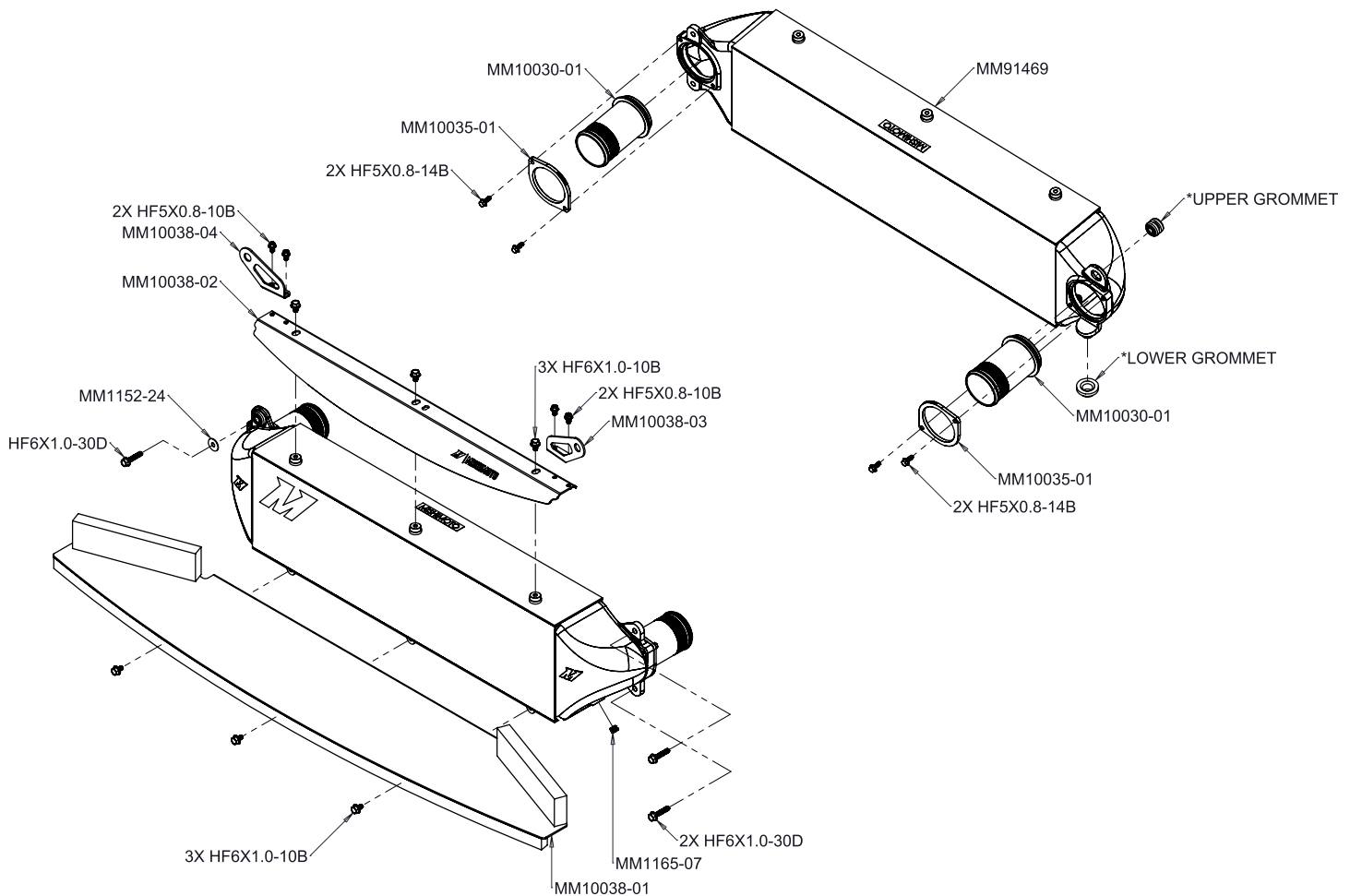

*PART IS REUSED FROM OEM INTERCOOLER AND IS NOT PROVIDED BY MISHIMOTO

For questions or assistance with your Mishimoto product, contact us at [1.877.GOMISHI](tel:1877GOMISHI) or SUPPORT@MISHIMOTO.COM

Continued on next page

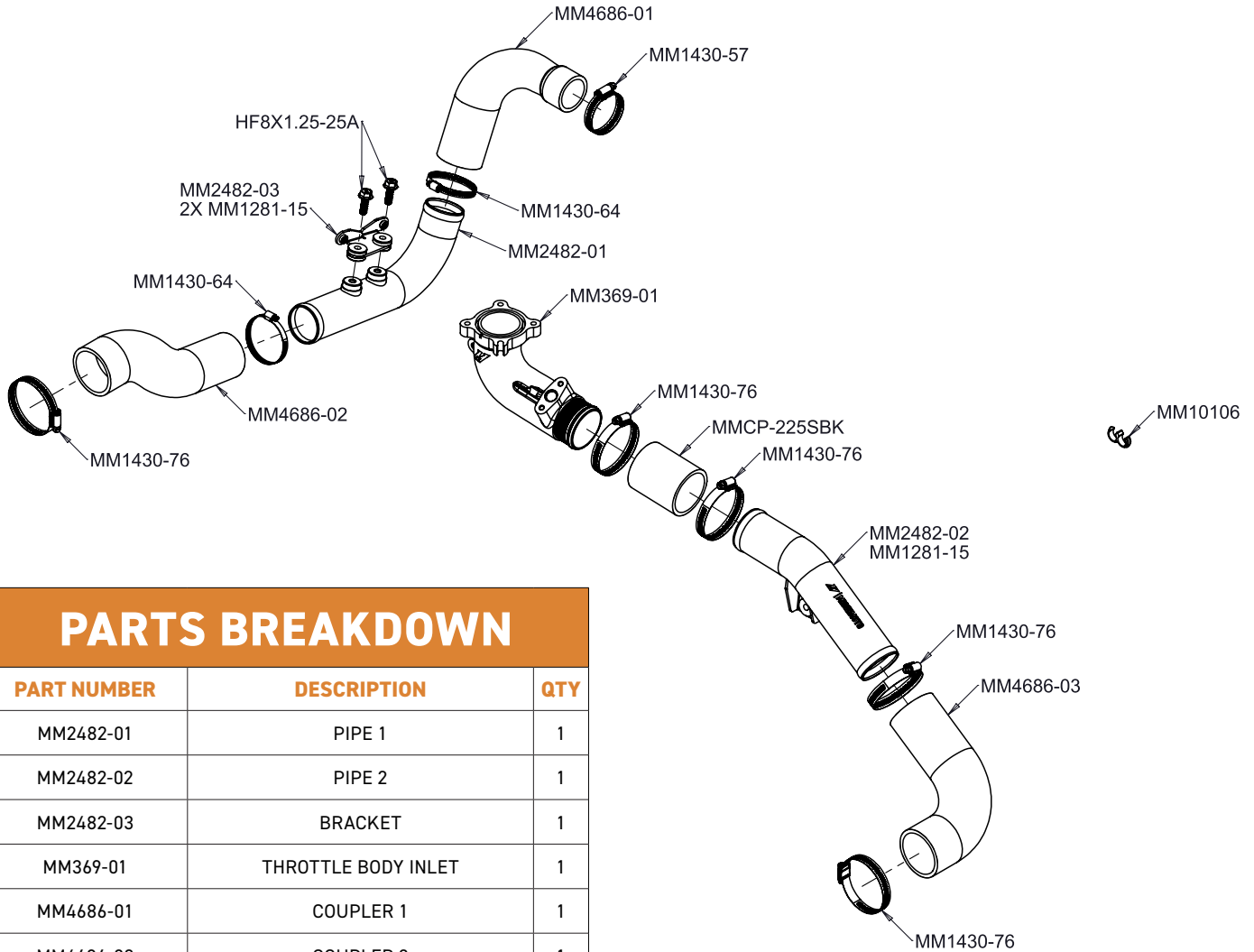

PARTS BREAKDOWN

PART NUMBER	DESCRIPTION	QTY
MM2482-01	PIPE 1	1
MM2482-02	PIPE 2	1
MM2482-03	BRACKET	1
MM369-01	THROTTLE BODY INLET	1
MM4686-01	COUPLER 1	1
MM4686-02	COUPLER 2	1
MM4686-03	COUPLER 3	1
MMCP-225SBK	STRAIGHT COUPLER	1
MM10106	TUBE CLIP	1
HF8X1.25-25A	M8 BOLT (25MM LENGTH)	2
MM1281-15	GROMMET	3
MM1430-57	WORM GEAR CLAMP (33-57MM)	1
MM1430-64	WORM GEAR CLAMP (40-64MM)	2
MM1430-76	WORM GEAR CLAMP (52-76MM)	5

Continued on next page

IMPORTANT SAFETY INFORMATION

- › Mishimoto recommends you use safety glasses and protective gloves during the installation of our products
- › Raise vehicle only on jack stands or on a vehicle lift
- › Allow vehicle to cool completely prior to attempting installation
- › Do not run the engine or drive the vehicle while overheating; serious damage can occur
- › Please dispose of any liquids properly
- › Mishimoto is not responsible for any vehicle damage or personal injury due to installation errors, misuse, or removal of Mishimoto products
- › If you need any assistance while installing our products, reach out to our Customer Service Team at 1-877-GOMISHI

REQUIRED TOOLS

RATCHET	10MM WRENCH
EXTENSION	12MM WRENCH
7MM SOCKET	TORQUE WRENCH
8MM SOCKET	FLATHEAD SCREWDRIVER
10MM SOCKET	PICK TOOL
12MM SOCKET	PANEL TOOL
14MM SOCKET	

INSTALL TIME: 8 HOURS

INSTALL DIFFICULTY: 

INSTALLATION INSTRUCTIONS

1. Jack up the front of the vehicle and place it on jack stands.
2. Disconnect the negative terminal from the battery.
3. Using a 10mm socket, remove the ten (10) bolts that secure the lower bumper tray. Then, remove the nine (9) pop clips that secure the splash shield using a flathead screwdriver or pop clip tool. Remove the tray and splash shield.

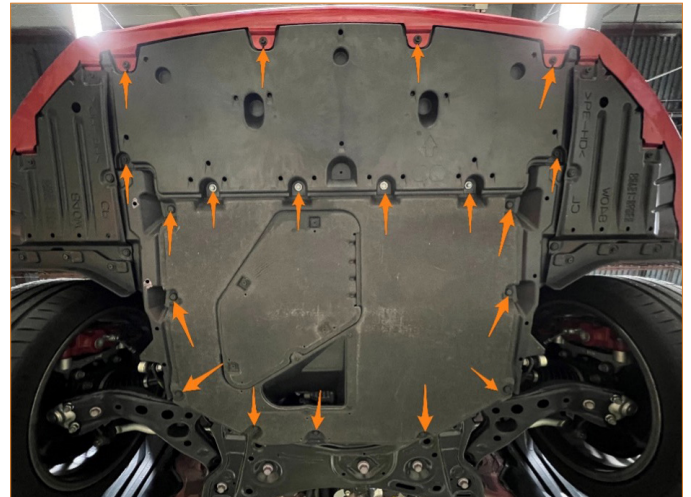

4. Remove the remaining six (6) bolts securing the bumper.



5. Remove the two (2) pop clips. Using a flathead screwdriver, remove the bumper clip. Repeat on the other wheel well.



Continued on next page

6. Remove the seven (7) pop clips securing the plastic tray at the front of the engine bay and remove the tray from the vehicle.



7. Using a 10mm socket, remove the three (3) bolts securing the top of the bumper to the vehicle. Then, remove the pop clip securing the snorkel duct.



8. Disconnect the electrical connector from the ADAS radar in the center of the bumper. Then, carefully pull each end of the bumper away from the vehicle to begin to disconnect it. Disconnect the electrical connectors from the fog light on each side of the bumper before entirely removing the bumper.



9. Remove the bumper.

10. Remove the foam from the crash bar by pulling it straight out.



11. Using a 10mm socket, remove the nut that attaches the bracket to the bottom center of the crash bar. Then, unclip the plastic wire harness mount from the top of the crash bar. Then, using a 14mm socket, remove the eight (8) bolts that secure the crash bar and remove the bar from the vehicle. During reassembly torque the crash bar bolts to 49 ft-lb (67Nm).

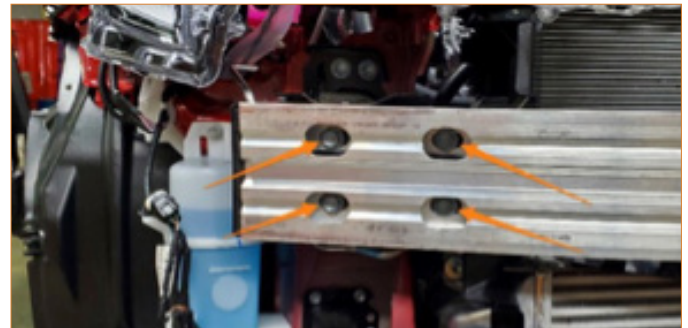
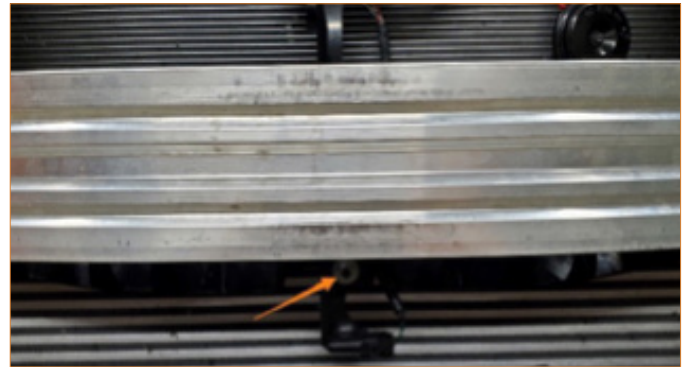

12. Remove the two (2) pop clips securing the lower intercooler shroud, then remove the shroud.



Continued on next page

13. Using a 12mm socket, remove the two (2) nuts securing the support bar and then remove the support bar. During reassembly, torque the nuts to 24 ft-lb (32 Nm).

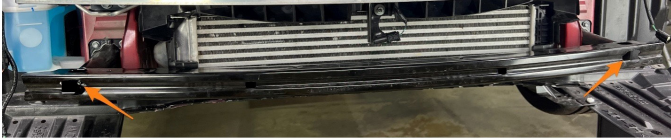

14. Remove the two (2) pop clips from the air duct. Disengage the clips connecting the left and right shrouds to the air duct. Remove the ambient air temperature sensor tree clip from the duct, and then remove the duct.



15. Remove the left and right plastic shrouds by pulling straight out until the clips disengage and the shrouds are free.

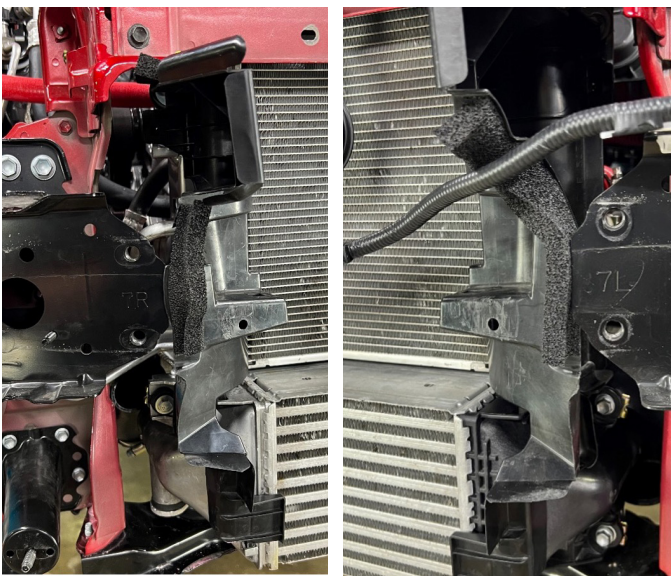

16. Loosen the hot side and cold side intercooler coupler clamps. Disconnect the couplers from the intercooler.

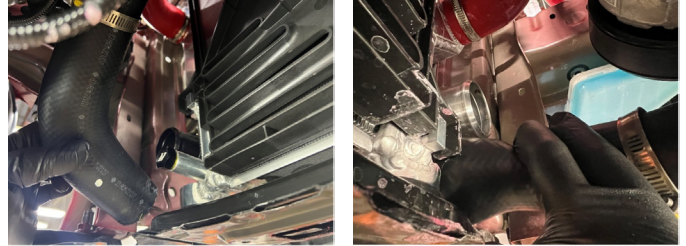

17. Using a 10mm socket, remove the three (3) bolts securing the intercooler.

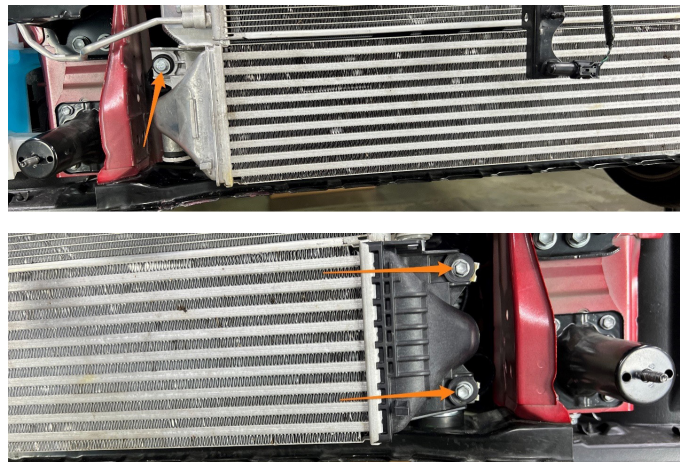

18. Lift up on the left side of the intercooler, then pull the intercooler straight out. Once out, lower the intercooler to avoid the ambient air temperature sensor.

19. Remove the rubber grommets from the stock intercooler and install them onto the Mishimoto intercooler.

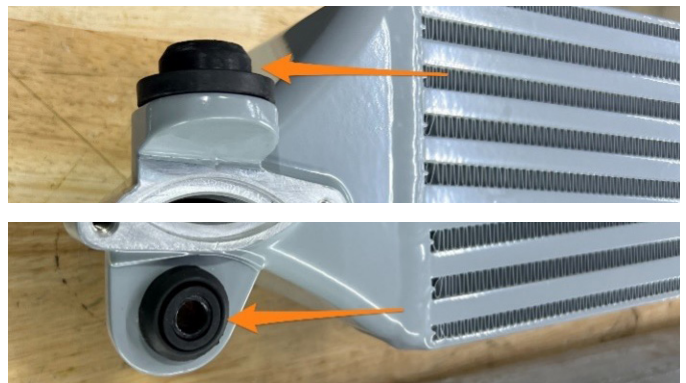

Continued on next page

20. Locate the O-rings included in the kit. Lubricate the O-rings with silicone grease, then install them onto the intercooler inlet and outlet adapters.



21. Carefully press the inlet and outlet adapters into the intercooler O-ring grooves. Place the locking rings over the flanges. Using an 8mm socket, secure the locking rings with the four (4) included bolts. Torque the bolts to 5Nm (44.5in/lb).



22. Place the Mishimoto intercooler into the vehicle. Be careful not to damage the ambient air temperature sensor. Ensure the intercooler post and grommet are sitting in the lower mount. Using a 10mm socket, install the three (3) included bolts and washer. The washer goes on the longer bolt installed on the intercooler's passenger side.

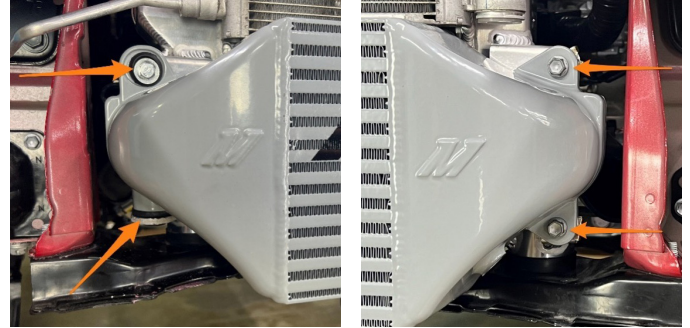

23. Reinstall the left and right shrouds.



24. Install the Mishimoto upper intercooler shroud. Use a 10mm socket to install the three (3) included bolts. Install the provided brackets to the upper intercooler shroud using the included 8mm bolts. Reinstall the two (2) pop clips for the left and right ducts. Insert the ambient air temperature sensor tree clip into the provided hole.



25. Install the Mishimoto lower intercooler shroud. Using a 10mm socket, secure the shroud with the three (3) included bolts.



Continued on next page

26. Loosen the clamp securing the hot-side intercooler pipe to the turbo.

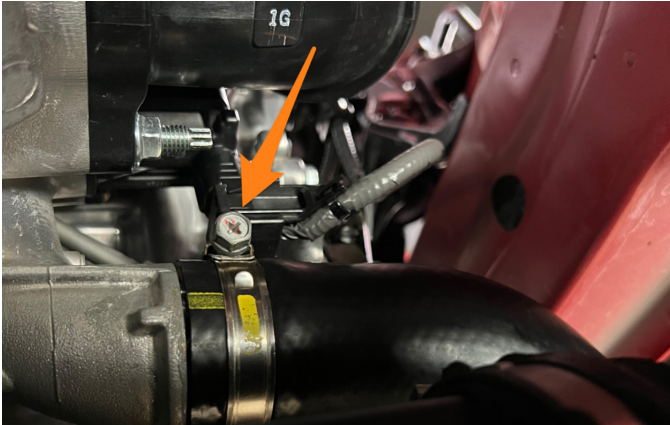

27. Remove the 10mm bolts securing the hot-side intercooler pipe to the front subframe. Then, remove the pipe from the vehicle.

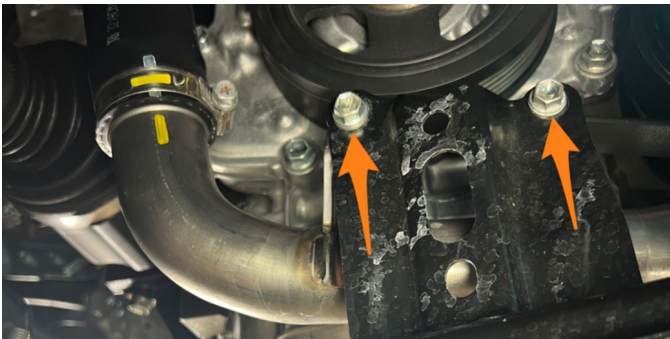

28. Remove the 12mm bolt securing the cold-side intercooler pipe to the front of the transmission.



29. Using a 3/8" square drive, rotate the serpentine belt tensioner enough to remove the serpentine belt.

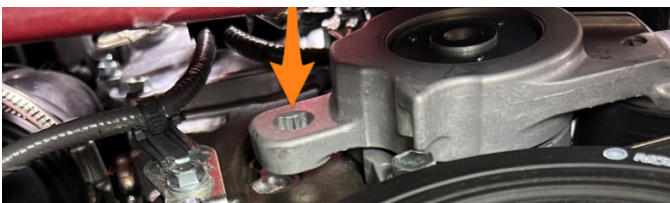

30. Disconnect the electrical connectors from the AC compressor and engine oil filter housing.

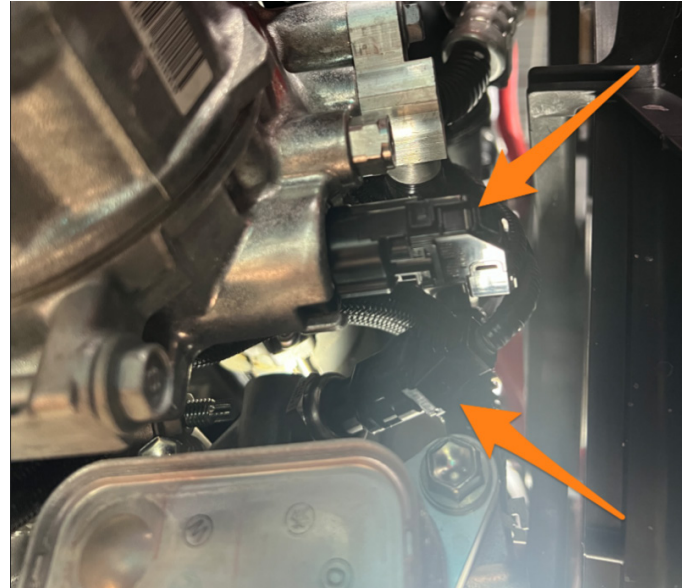

31. Separate the gray and black electrical connectors located above the alternator.

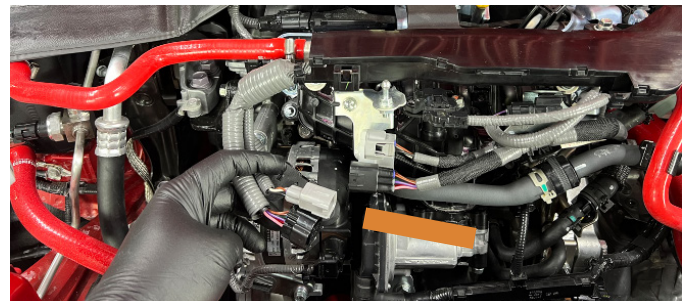

32. Remove the 12mm nuts and 12mm bolt securing the alternator in place. Then, remove the alternator and rest it on top of the engine.

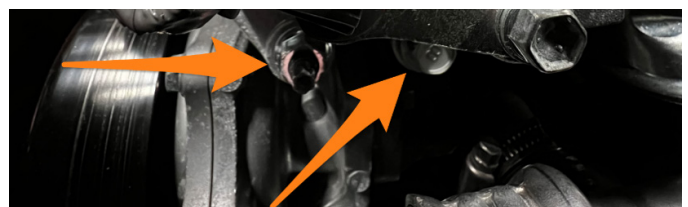

Continued on next page

33. Disconnect the MAP sensor electrical connector. Unclip the wire harness connector from its bracket. Remove the 10mm bolt securing the wire harness tray in place. Then, depress the tab and lift it upwards to remove it from its mounting bracket.

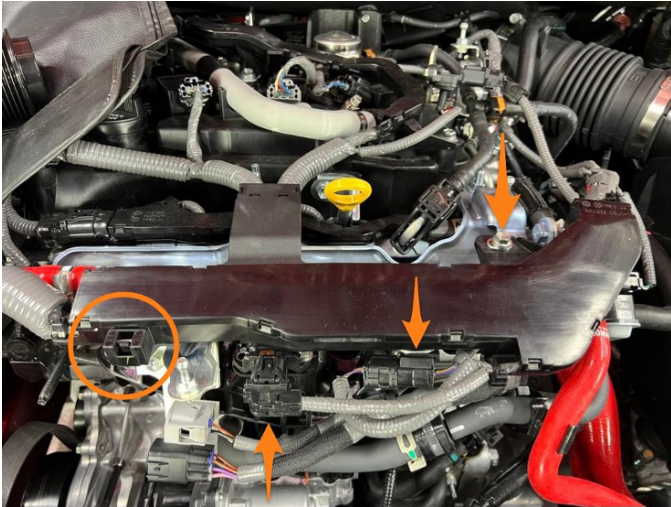

34. Remove the 10mm bolts securing the coolant crossover tube to the intake manifold.

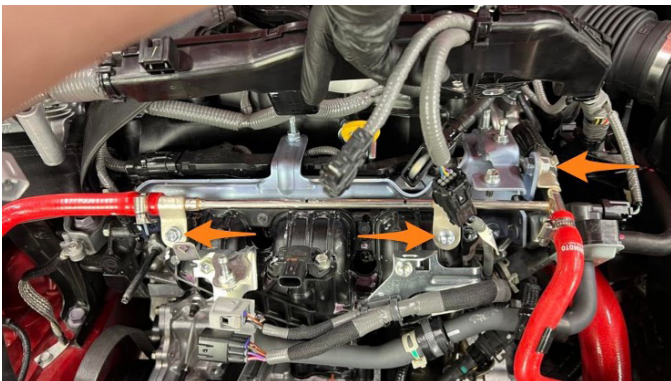

35. Disconnect the vacuum line.

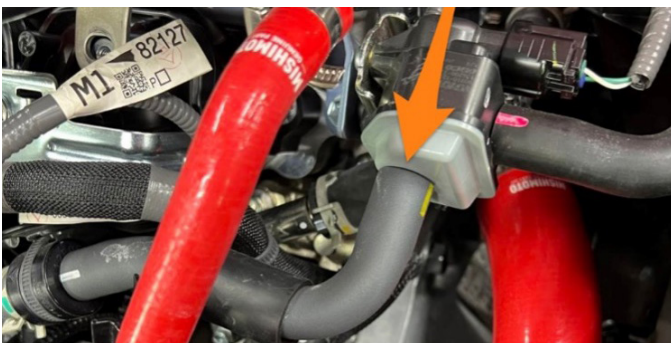

36. Remove the 10mm bolts securing the wire harness brackets to the intake manifold.

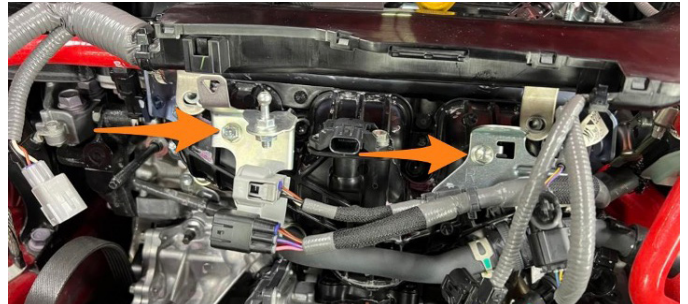

37. Disconnect the fuel pressure sensor.

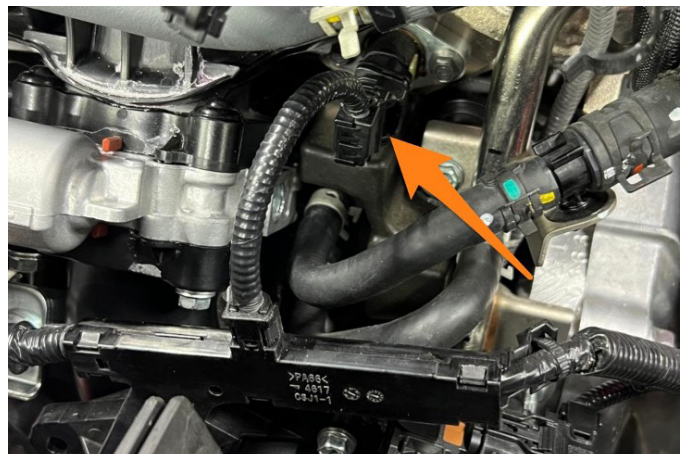

38. Remove the 10mm bolt securing the wire harness tray to the throttle body inlet and disconnect the throttle body.

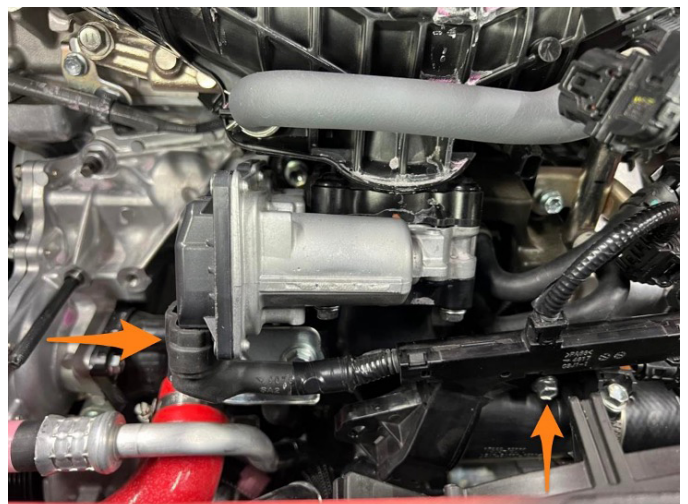

Continued on next page

39. Depress the locking tabs on the wire harness tray to release it from the throttle body inlet.



40. Disconnect the TMAP sensor.

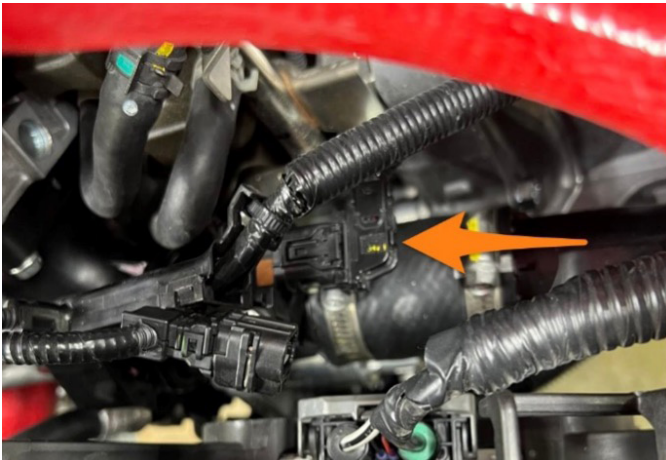

41. Disconnect the starter motor connector and move the harness out of the way.

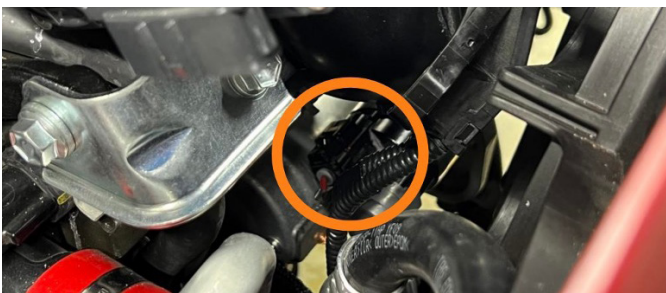

42. Remove the 12mm bolts securing the intake manifold support bracket to the engine and throttle body inlet.



43. Remove the 12mm bolts and 12mm nuts securing the intake manifold to the cylinder head.

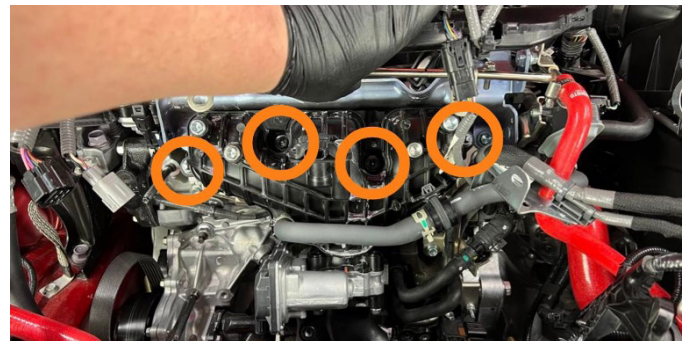

44. Remove the four 10mm bolts securing the throttle body inlet to the intake manifold.

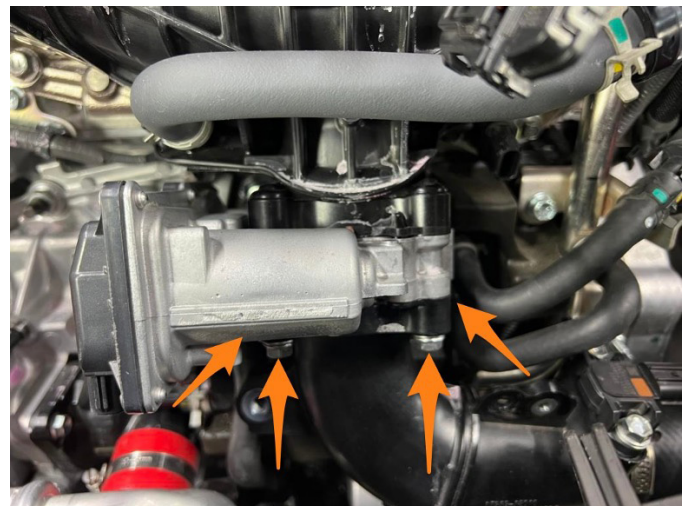

Continued on next page

45. Transfer the gasket and TMAP sensor from the stock throttle body inlet to the Mishimoto throttle body inlet. Reuse the bolts from the stock throttle body inlet to secure the sensor in place.

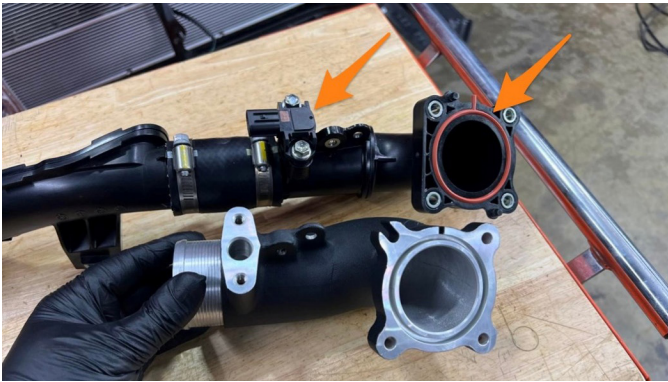

46. Fasten the Mishimoto throttle body inlet to the throttle body and intake manifold using the previously removed hardware. Notice the slotted mounting hole on the Mishimoto throttle body inlet, loosely install this bolt to the throttle body and intake manifold first, then slide the Mishimoto throttle body inlet into place. Torque the bolts to 10Nm (7ft/lb).

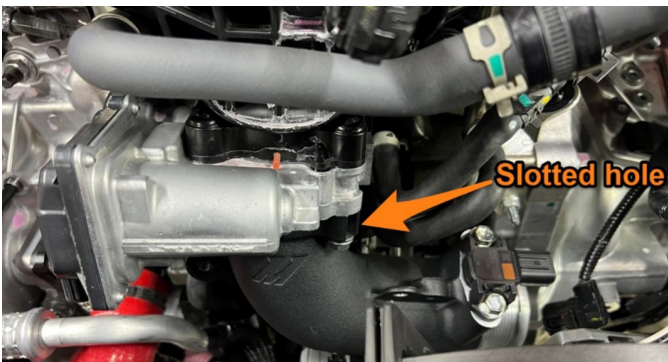

47. Reinstall the intake manifold using the previously removed 12mm bolts and 12mm nuts. Tighten the fasteners in the pattern shown in the image below. Torque the fasteners to 21Nm (15ft/lb).

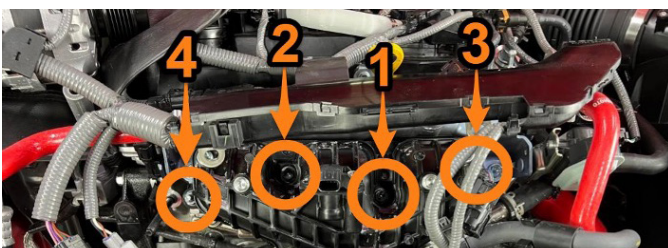

48. Reinstall the intake manifold support bracket to the engine and throttle body inlet using the previously removed 12mm bolts. Torque the bolts to 21Nm (15ft/lb).

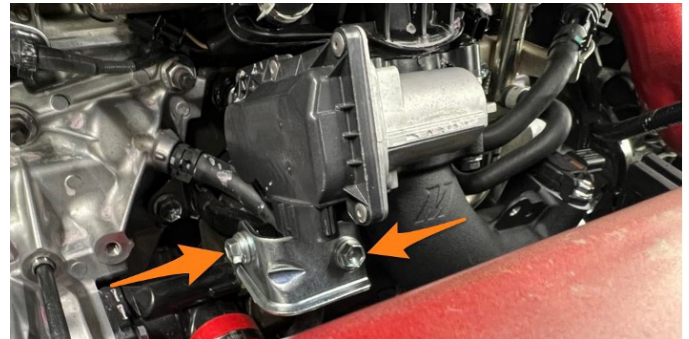

49. Reconnect the starter motor connector.

50. Reconnect the TMAP sensor.

51. Secure the wire harness tray to the throttle body inlet using the previously removed 10mm bolt and reconnect the throttle body connector.

52. Reconnect the fuel pressure sensor.

53. Secure the wire harness brackets to the intake manifold using the previously removed 10mm bolts.

54. Reconnect the vacuum line.

55. Secure the coolant crossover tube to the intake manifold using the previously removed 10mm bolts.

56. Position the harness tray onto its mounting bracket and secure it in place with the previously removed 10mm bolt. Clip the previously removed wire harness back into place on the bracket. Reconnect the MAP sensor electrical connector.

57. Reinstall the alternator using the previously removed hardware and torque to 25Nm (18ft/lb).

58. Reconnect the gray and black electrical connectors located above the alternator.

59. Reconnect the electrical connectors to the AC compressor and engine oil filter housing.

60. Using a 3/8" square drive, rotate the serpentine belt tensioner enough to reinstall the serpentine belt.

Continued on next page

61. Using two of the provided worm gear clamps (MM1430-76) and the straight coupler (MMCP-225SBK), connect pipe 2 (MM2482-02) to the throttle body inlet. Do not fully tighten the clamps, this will be done in a later step.

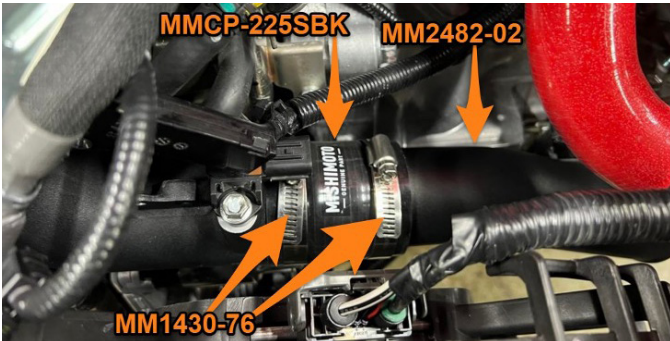

62. Secure pipe 2 (MM2482-02) to the front of the transmission with the previously removed 12mm bolt.



63. Install the longer straight section of coupler 3 (MM4686-03) to pipe 2 (MM2482-02) and loosely secure it in place with one of the provided worm gear clamps (MM1430-76). Install the other end of coupler 3 to the intercooler outlet and loosely secure it in place with one of the provided worm gear clamps (MM1430-76).

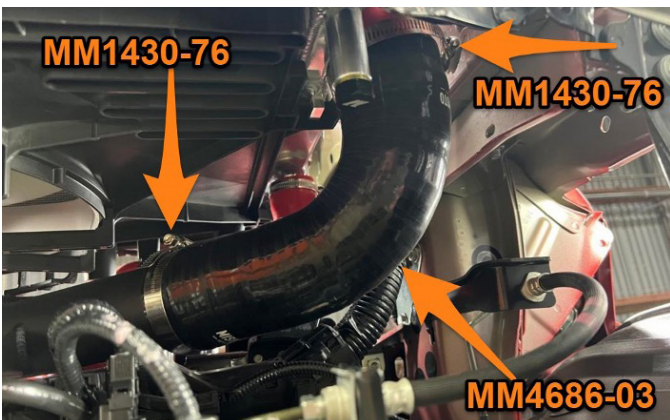

64. Tighten the clamps that were installed in steps 61 and 63.

65. Loosely install coupler 1 (MM4686-01) to the turbo outlet using one of the provided worm gear clamps (MM1430-57).

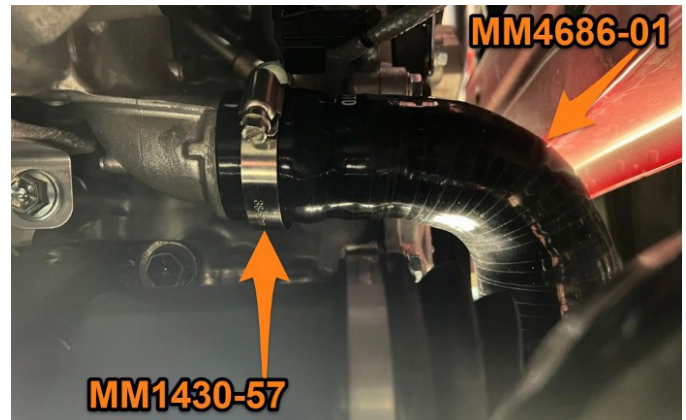

66. Install the provided bracket (MM2482-03) to pipe 1 (MM2482-01) using the provided hardware (2x HF8X1.25-25A).



67. Loosely install pipe 1 (MM2482-01) to coupler 1 (MM4686-01) using one of the provided worm gear clamps (MM1430-64). Fasten the bracket on pipe 1 to the front subframe using the previously removed 10mm bolts. Do not tighten the bolts, this will be done in a later step.



Continued on next page

68. Install the smaller diameter end of coupler 2 (MM4686-02) to pipe 1 (MM2482-01) and loosely secure it in place with one of the provided worm gear clamps (MM1430-64). Install the larger diameter end to the intercooler inlet and loosely secure it in place with one of the provided worm gear clamps (MM1430-76).

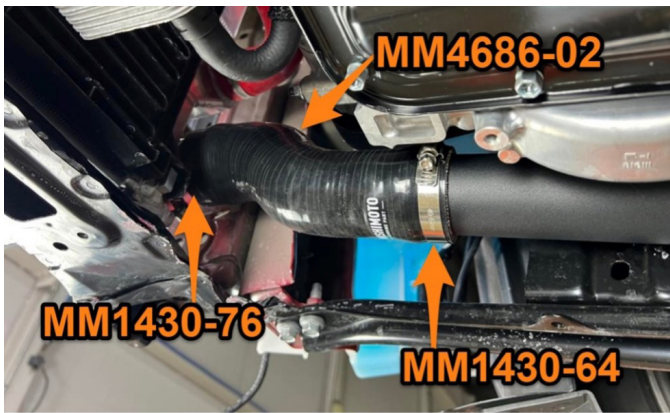

69. Tighten the clamps that were installed in steps 65, 67, and 68. Tighten the bolts that were installed in step 67.

70. Install the provided tube clip (MM10106) to the throttle body coolant hoses.

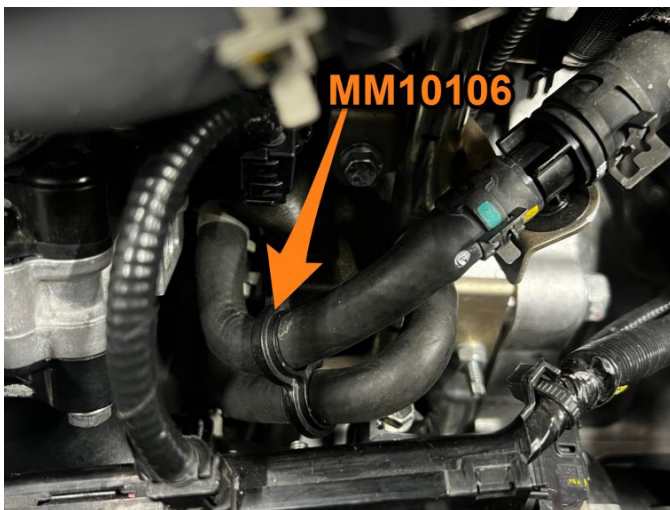

71. Reinstall the remaining components in the reverse of removal.

Congratulations! You have completed your installation.

Continued on next page

DISPOSAL INSTRUCTIONS

- › Do not dispose of any product as unsorted municipal waste. Use separate collection facilities. Contact your local authority for information regarding the collection systems available.
- › Never improperly dispose of any coolant, oil, or other chemicals

WARRANTY INFORMATION



- › All claims must be accompanied with a picture of the Mishimoto product showing the issue for which the claim is being submitted.
- › Mishimoto asks that the customer inspect their purchased item for any damage immediately upon arrival.
- › Any product deemed dead on arrival (DOA) must be claimed within 14 business days of delivery. Claims outside of this time frame will not be covered under the Mishimoto Lifetime Warranty.
- › This warranty does not include payment and/or reimbursement of the cost of labor in connection with the removal of any product returned pursuant to the warranty policy or in connection with the installation of any replacement items provided under the warranty policy.
- › Mishimoto has the right to refuse a claim at any time.

- › When Mishimoto accepts a claim, Mishimoto retains full discretion to choose if it will: (i) repair or replace purchaser's original Mishimoto product; (ii) replace purchaser's original Mishimoto product with the most current available model; or (iii) provide the purchaser with a gift card redeemable on [Mishimoto.com](https://www.mishimoto.com) in the amount of the original purchase price of the original Mishimoto product. The provision of a replacement of a Mishimoto product is subject to availability and Mishimoto retains the right to substitute any warranty claim item with a comparable item or credit at any time.
- › If Mishimoto determines that it will provide a replacement item in connection with a claim under this warranty policy, and such item is out of stock, Mishimoto will place the customer on backorder and ship the replacement product to the purchaser once it becomes available.
- › Mishimoto is not liable for incorrect shipments in connection with a claim if a claim form is completed incorrectly, or if a model number is not included in a claim.
- › If you have a vehicle equipped with an automatic transmission, please make sure to specify this within the text box on the claim form. Mishimoto is not responsible for incorrect replacement shipments if transmission type is not indicated.



WARNING
Cancer and
Reproductive Harm
www.P65Warnings.ca.gov

- › This product can expose you to chemicals which are known to the state of California to cause cancer. For more information visit: www.p65warnings.ca.gov